

Bodengruppe (Unterseite)	Spannung	Baugruppe	Ausgabe	gültig ab Seriennummer
Bottom (Lower elevation)	Voltage	Group	Edition	Application from Serial.No.
	3 N AC 400V 50Hz	10	10.1.1	C21D93065001

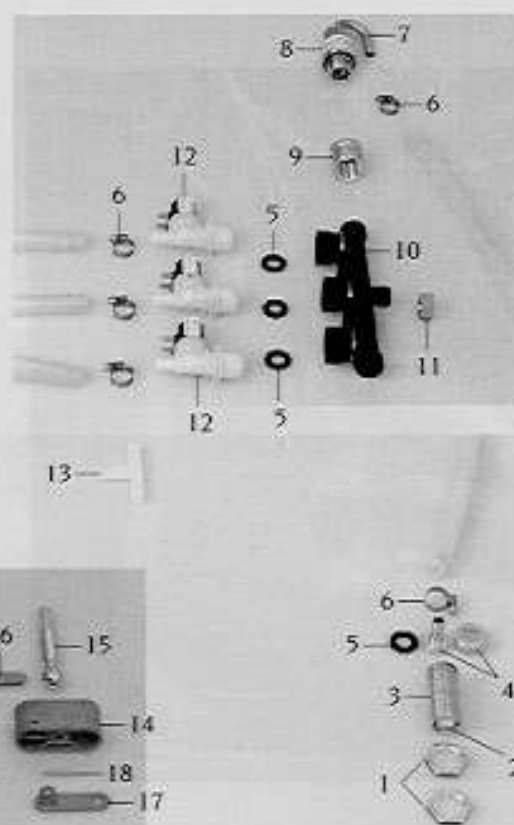

Pos.	St.	Ersatz.Nr.	Bezeichnung	Description
Pos.	Pcs.	Sp. Part No.		
-	-	2067.0050	Silikon Schlauch 1m	Silicone hose 1m
-	4	8664.1017	Gerätefuß kpl.	Foot adjustable cpl.
1	2	2062.0313	Kontermutter G 3/4	Lock-nut G 3/4
2	1	1900.0202	Wasserfilter grob	Water filter coarse
3	1	1500.1582	Gewindenippel G3/4"	Thread nipple G3/4"
4	1	2062.0314	Geradeverschraubung G 3/4	Straight threaded joint G 3/4
5	4	5110.1024	Dichtung für Verschraubung G 3/4"	Gasket for G3/4" threaded joint
6	5	2066.0205	Schlauchschelle 12-18mm	Hose clamp 12-18mm
7	1	1500.1571	Rohranschluß	Tube connection
8	1	2069.0102	Armaturenkombination	Valve unit with non-return valve
9	1	1500.1572	Muffe G3/4"	Threaded sleeve G3/4"
10	1	8664.1007	Wasserverteiler	Water distribution unit
11	1	1500.1261	Verschlußkappe G1/2"	Screw cap G1/2"
-	1	5012.0539	Dichtung für Verschraubung G 1/2"	Gasket for G1/2" threaded joint
12	3	3002.0331	Einfachmagnetventil kpl. 220-240V/50Hz	Single solenoid valve unit 220-240V/50Hz
13	1	2062.0302	T-Stück TS10	T-piece TS 10
-	2	1106.0801	Sechskant-Combi-Mutter M 6	Hexagonal combination nut M6
14	2	2039.0104	Fußunterteil	Lower part for foot adjustable
15	4	2120.1037	Spindel für Gerätefuß	Spindle for foot adjustable
-	4	1805.1801	Spannhülse A5x12	Adapter sleeve A5x12
16	4	2039.0105	Kunststoffabdeckung	Cover plate
17	4	8664.1018	Fußarretierung	Arrestment for foot adjustable
18	4	1005.1906	Zylinderstift A5x32	Straight pin A5x32

<b>Bodengruppe (Oberseite)</b> <b>Bottom (Top elevation)</b>	<b>Spannung</b> <b>Voltage</b>	<b>Baugruppe</b> <b>Group</b>	<b>Ausgabe</b> <b>Edition</b>	<b>gültig ab Seriennummer</b> <b>Application from Serial.No.</b>
	3 N AC 400V 50Hz	9	9.1.1	C21D93065001

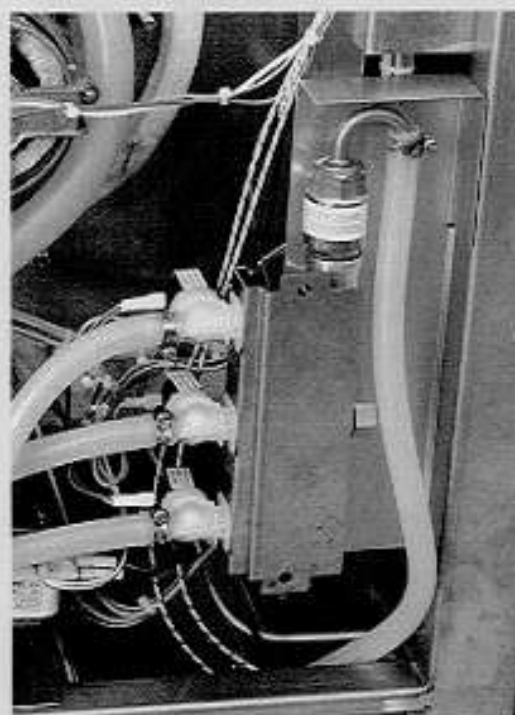
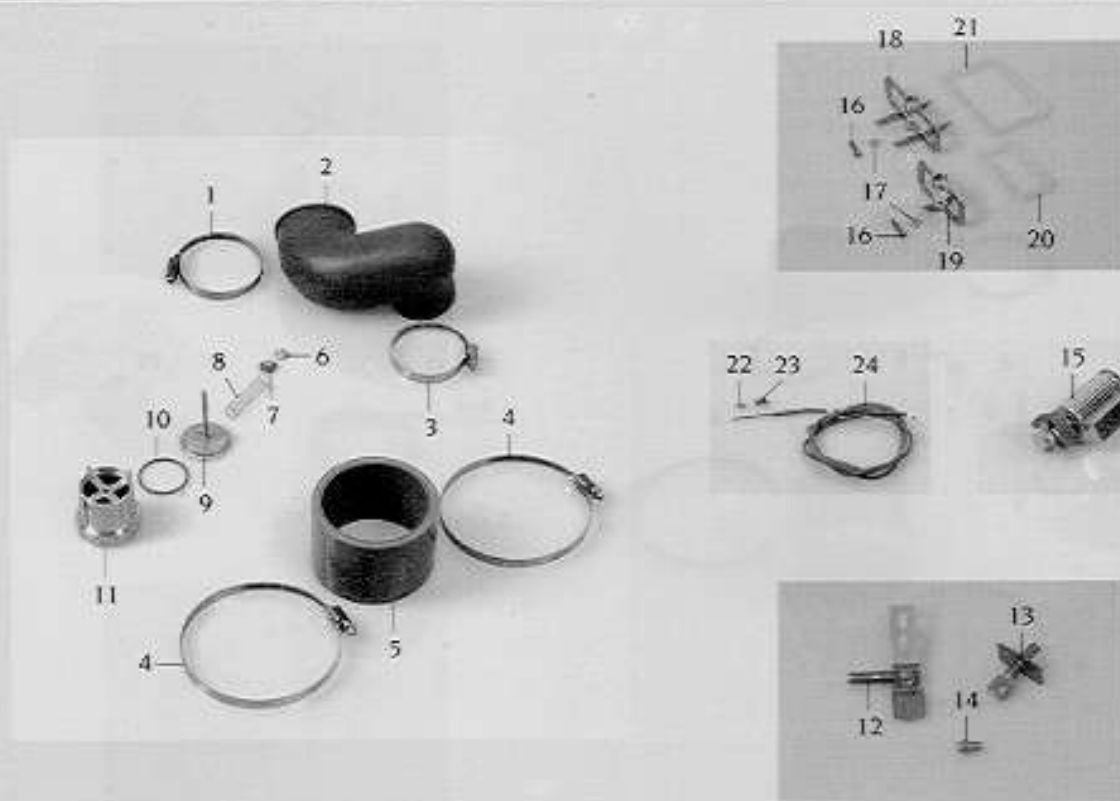

Pos.	St.	Ersatz.Nr.	Bezeichnung	Description
Pos.	Pcs.	Sp. Part No.		
-	-	2067.0050	Silikonschlauch 1m	Silicone hose 1m
-	1	8450.1001	Sicherheitsventil kpl.	Safety valve unit
1	1	2066.0300	Schlauchschelle 50-70mm	Hose clamp 50-70mm
2	1	5012.0570	Haube f. Sicherheitsventil	Cap for safety valve
3	1	2066.0504	Schlauchschelle 40-60mm	Hose clamp 40-60mm
4	2	2066.0524	Schlauchschelle 90-110mm	Hose clamp 90-110mm
5	1	2112.1016	Dampfschlauch 80x7mm	Steam hose 80x7mm
6	1	1107.0100	Schnellbefestiger 4,0 mm	Quick fastener 4.0 mm
7	1	1105.0122	Sechskant-Combi-Mutter M 5	Hexagonal combination nut M5
8	1	2064.1002	Unterdruckfeder f. Sicherheitsventil	Vacuum/depression spring for safety valve
9	1	2064.1001	Unterdruckstempel f. Sicherheitsventil	Vacuum/depression ram for safety valve
10	1	2064.1003	Unterdruckdichtung f. Sicherheitsventil	Vacuum/depression gasket for safety valve
11	1	2064.1000	Überdruckgewicht f. Sicherheitsventil	Overpressure weight for safety valve
-	1	2064.1004	Überdruckgewichtdichtung f. Sicherheitsventil	Overpressure weight gasket for safety valve
12	1	8666.1049	Ablöschdüse Ablaufkasten	Quenching nozzle for outlet box
13	3	8666.1045	Ablöschdüse kpl. 3,9 l/min.	Quenching nozzle unit 3.9 l/min.
-	3	5110.1013	Dichtung Ablöschdüse	Gasket for quenching nozzle
14	1	2035.0111	Zungendüse für Beschwadung	Moistening nozzle
15	1	3101.1004	Querstromlüfter	Cooling fan
16	2	1008.0751	Sechskantschraube M5x25	Hexagonal screw M 5x25
17	2	1315.0260	Unterlegscheibe A5,3	Washer A5,3
18	1	2940.1014	Fixierung groß für Gerätedeckel	Large fixing for top cover
19	1	2940.1016	Fixierung klein für Gerätedeckel	Small fixing for top cover
20	1	5110.1019	Dichtung klein für Ablöschkanal/ Gerätedeckel	Small gasket for quenching channel/top cover
21	1	5110.1018	Dichtung groß für Ablöschkanal/ Gerätedeckel	Large gasket for quenching channel/top cover
22	1	3014.0162	Dichtkegel für Thermoelement	Sealing cone for thermo element
23	1	3014.0163	Stopfbuchsnippel für Thermoelement	Gasket sleeve with nipple
24	1	3014.0161	Mantelthermoelement	Sheath thermo element

<b>Bedienblende</b> Control Panel	Spannung Voltage 3 N AC 400V 50Hz	Baugruppe Group 1	Ausgabe Edition 1.1.1	gültig ab Seriennummer Application from Serial.No. C21D93065001
--------------------------------------	---	-------------------------	-----------------------------	---

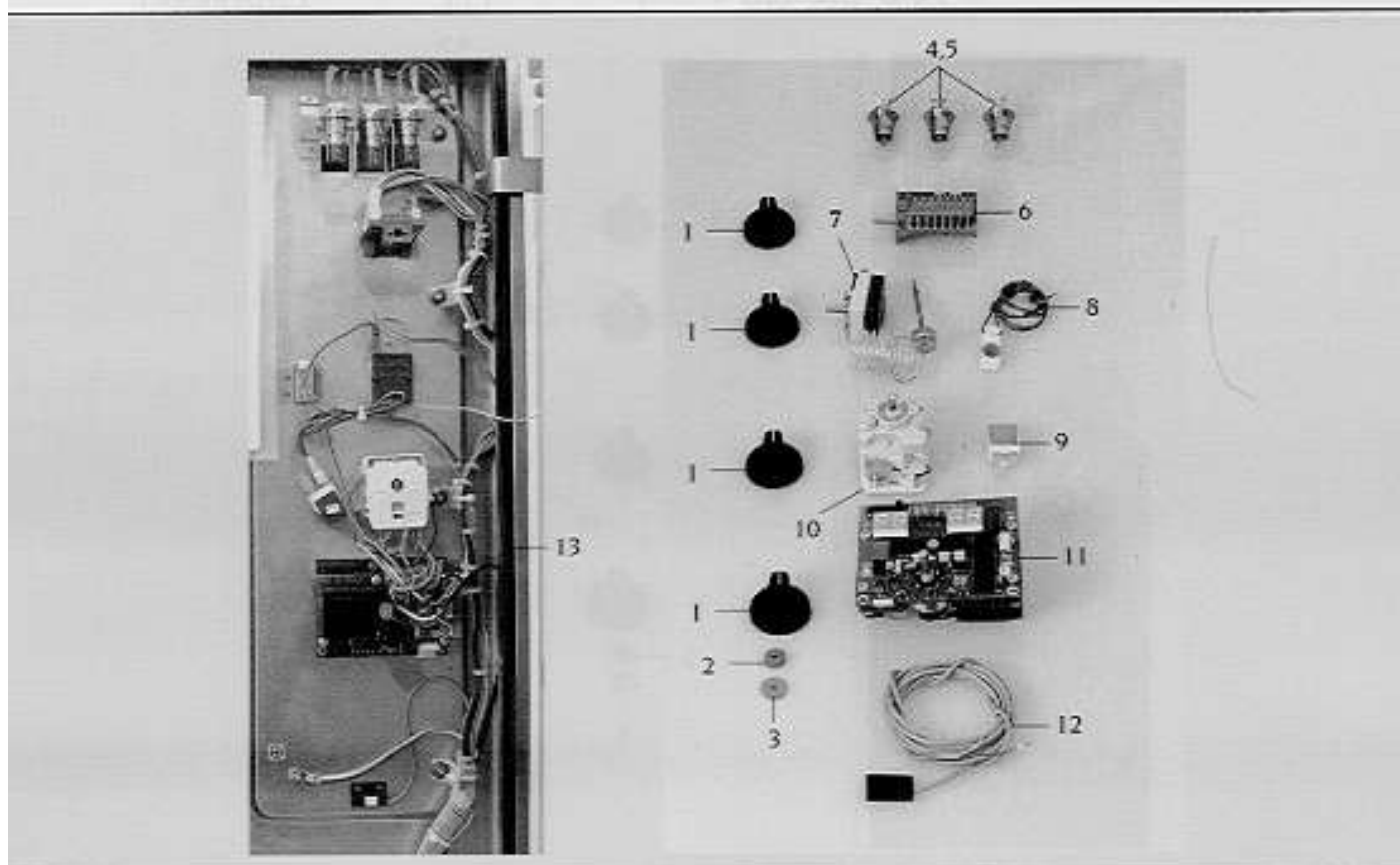

Pos.	St.	Ersatz-Nr.	Bezeichnung	Description
Pos.	Pcs.	Sp. Part No.		
1	4	3013.0344	Knebel CCD/CCM blau Ø 60mm	Dial CCD/CCM blue Ø 60mm
		3013.0330	Knebel CCD/CCM blau Ø 40mm	Dial CCD/CCM blue Ø 40mm
2	4	2022.0100	Silikon-Dichtscheibe	Silicone gasket
3	4	5110.1027	Distanzscheibe 61-202	Distance plate 61-202
4	3	3024.0305	Fassung für Kontrolleuchte	Socket for control lamp
5	3	3025.0306	Glühlampe für Kontrolleuchte	Bulb for control lamp
6	1	3016.1612	Betriebsartenschalter CCD	Mode switch block type CCD
7	1	3014.0166	Thermostat Heißluft/ Gerät zu heiß	Thermostat hot air/ unit too hot
8	1	3024.0307	Heizungskontrolleuchte	Heating control lamp
9	1	3006.0101	Alarmsummer	Alarm buzzer
10	1	3013.0104	Zeitschaltuhr 120min.	Timer 120 min.
11	1	3035.0660	Kerntemperaturregelung	PCB for core temperature
12	1	3016.1408	Türkontaktschalter	Door contact switch
13	1	5105.1013	Dichtungsrahmen f. Bedienblende	Gasket frame for panel

<b>Gerätetür</b> Door	Spannung Voltage	Baugruppe Group	Ausgabe Edition	gültig ab Seriennummer Application from Serial.No.
	3 N AC 400V 50Hz	8	8.1.1	C21D93065001

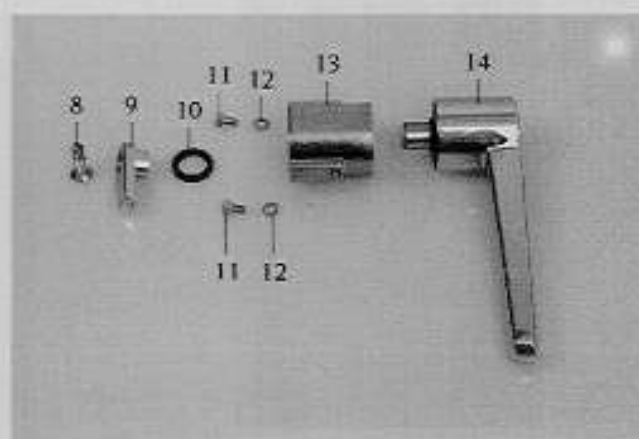

Pos.	St.	Ersatz.Nr.	Bezeichnung	Description
Pos.	Pcs.	Sp. Part No.		
-	1	8470.5001	Gerätetür kpl.	Door cpl.
-	1	5200.1003	Glasscheibe innen	Internal glass panel
-	1	5105.1005	Dichtungsrahmen für Glasscheibe	Gasket frame for internal glass panel
1	1	8474.1020	Glastür außen kpl.	External glass door unit
2	1	5105.1015	Dichtungsprofil HGW/ Garraum	Gasket profile HGW/ interior cabinet
3	1	5105.1007	Dichtungsrahmen Tür/ Garraum	Gasket frame door/ interior cabinet
4	2	1008.0761	Sechskantschraube M8x25	Hex screw M8x25
5	2	1206.0120	Zahnscheibe A6,4	Toothed lock washer A6,4
6	2	1308.0160	Unterlegscheibe A8,4	Washer A8,4
7	1	8514.1038	Fangkloben kpl.	Door catch cpl.
8	1	1008.1960	Senkschraube M8x30	Countersunk screw M8x30
-	1	2039.0309	Abdeck-Kappe	Silicone cap
9	1	2940.1004	Riegel	Door bolt
10	1	5110.1015	Dichtungsring	Sealing washer
11	2	1006.0760	Sechskantschraube M6x16	Hex screw M6x16
12	2	1306.0120	Unterlegscheibe A6,4	Washer A6,4
13	1	8474.1019	Verschluss kpl.	Lock unit
14	1	2016.1501	Türhebel	Door handle



Elektromontageplatte Electrical Installation	Spannung Voltage	Baugruppe Group	Ausgabe Edition	gültig ab Seriennummer Application from Serial.No.
	3 N AC 400V 50Hz	3	3.1.1	C21D93065001

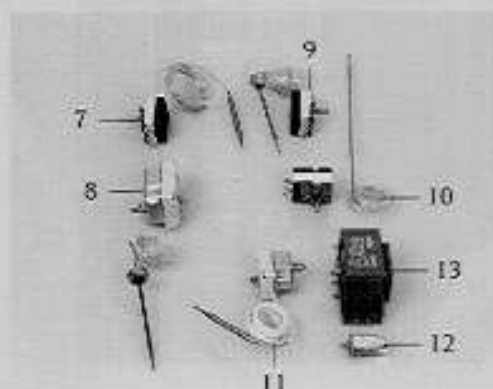
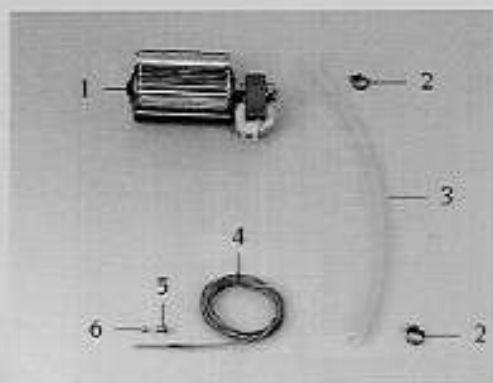
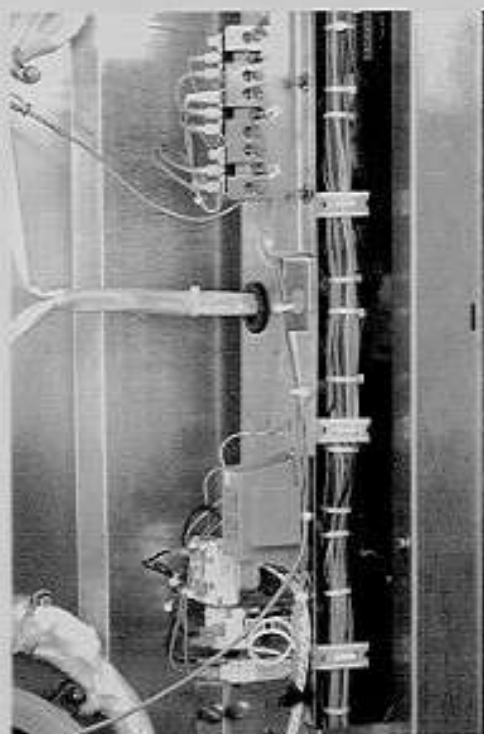

Pos. Pos.	St. Pcs.	Ersatz.Nr. Sp. Part No.	Bezeichnung	Description
1	1	3101.1004	Querstromlüfter	Cooling fan for electrical installation room
2	2	2066.0525	Schlauchklemme 22.1mm	Hose clamp 22.1mm
3	1	2112.1020	Silikonschlauch 15x3x750mm	Silicone hose 15x3x750mm
4	1	3014.0161	Mantelthermoelement	Sheath thermo element
5	1	3014.0163	Stopfbuchsnippel für Thermoelement	Gasket sleeve with nipple
6	1	3014.0162	Dichtkegel für Thermoelement	Sealing cone for thermo element
7	1	3014.0314	Thermostat Dampfgenerator	Thermostat for steam generator
8	1	3014.0322	Sicherheitstemperaturbegrenzer 360°C	Safety temperature limiter 360°C
9	1	3014.0166	Thermostat Heißluft/ Gerät zu heiß	Thermostat hot air/ unit too hot
10	1	3014.0312	Thermostat Ablöschung	Thermostat for quenching
11	1	3014.0300	Trockengeschutz 125 °C	Dry up protector 125 °C
12	1	3014.0400	Überstromauslöser einpolig f. Motorschutz	Current limiter for motor protection
13	1	3037.0204	Halogentrafo 20 VA	Halogen transformer 20 VA

Handbrause Hand Shower	Spannung Voltage	Baugruppe Group	Ausgabe Edition	gültig ab Seriennummer Application from Serial No.
	3 N AC 400V 50Hz	11	11.1.1	C21D93065001

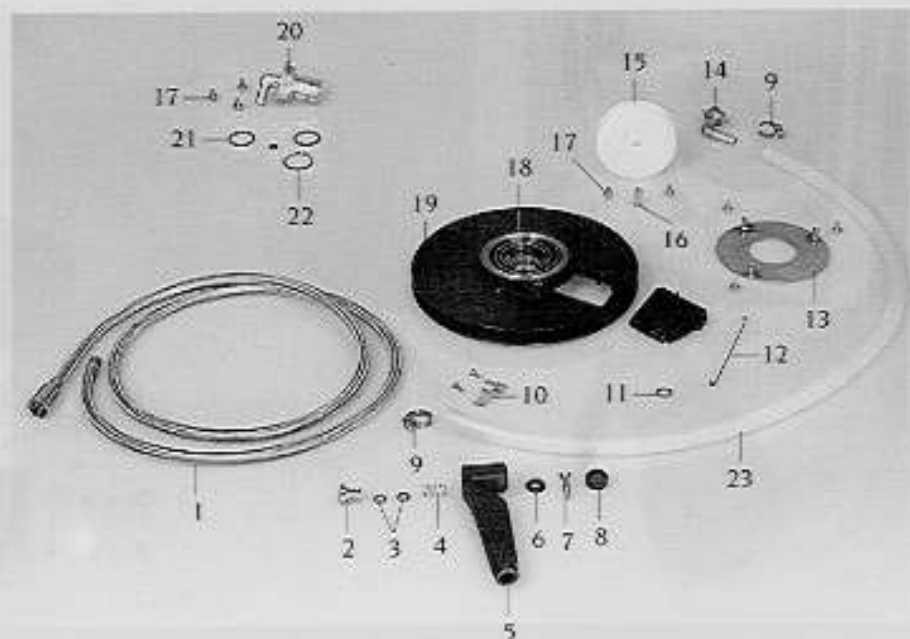

Pos. Pos.	St. Pcs.	Ersatz.Nr. Sp. Part No.	Bezeichnung	Description
-	-	8655.3000	Schlauchroller kpl.	Hand shower roll guide
1	1	2067.0607	Brauseschlauch 1500 mm	Shower hose 1500 mm
-	2	2060.0228	O-Ring	O-ring
2	1	2060.1001	Druckknopf für Handbrause	Push-button for hand shower
3	2	5012.0559	O-Ring f. Schlauchbrause d 7x2,5mm	O-ring d 7x2.5mm
4	1	2001.0110	Druckfeder f. Schlauchbrause	Compression spring
5	1	2060.1000	Handbrause kpl. (inkl.Pos 2-8)	Hand shower (incl.Pos 4-9)
6	1	5012.0558	O-Ring f. Schlauchbrause d 8x5mm	O-ring d 8x5mm
7	1	2060.1003	Steilkegelstift Handbrause	Steep taper pin for hand shower
8	1	2060.1002	Düse f. Handbrause	Jet for hand shower
9	1	2066.0205	Schlauchscheile 12-18mm	Hose clamp 12-18mm
10	1	2760.1159	Befestigungsschelle	Hose clamp
-	2	1003.0231	Kerbschraube 3.9x13 mm	Slotted screw 3.9 x 13 mm
11	1	2001.0203	Federmutter d 8mm	Spring nut d 8 mm
12	1	2001.0202	Bügel Feder f. Schlauchroller	Return spring for hose roll guide
13	1	8655.2005	Sicherungsscheibe	Locking plate
14	1	2062.0208	Winkelverschraubung G1/2"x10	Elbow screw point G1/2"x10
-	1	5012.0539	Dichtung für Verschraubung G 1/2"	Gasket for G1/2" threaded joint
15	1	2060.0112	Schlauchrolle	Roll guide
16	1	2060.0115	Achse für Schlauchrolle	Axle for roll guide
17	10	1005.2000	Sperrzahnschraube M5x8	Interlocking tooth screw M5x8
18	1	2001.0201	Spiralfeder f. Schlauchroller	Spiral coiled spring for hose roll guide
19	1	2060.0150	Schlauchrad für Handbrause	Retractable wheel for hand shower
20	1	2060.0157	Achse f. Schlauchroller	Axle for hose roll
21	1	8000.0081	Satz O-Ringe	Set O-ring
22	1	1250.0103	Sicherungsring 28mm	Snap ring 28mm
23	1	2067.0159	Silikonschlauch 900mm	Silicone hose 900mm

<b>Heißluftheizung</b> <b>Hot Air Heating</b>	Spannung Voltage	Baugruppe Group	Ausgabe Edition	gültig ab Seriennummer Application from Serial.No.
	3 N AC 400V 50Hz	5	5.1.1	C21D93065001

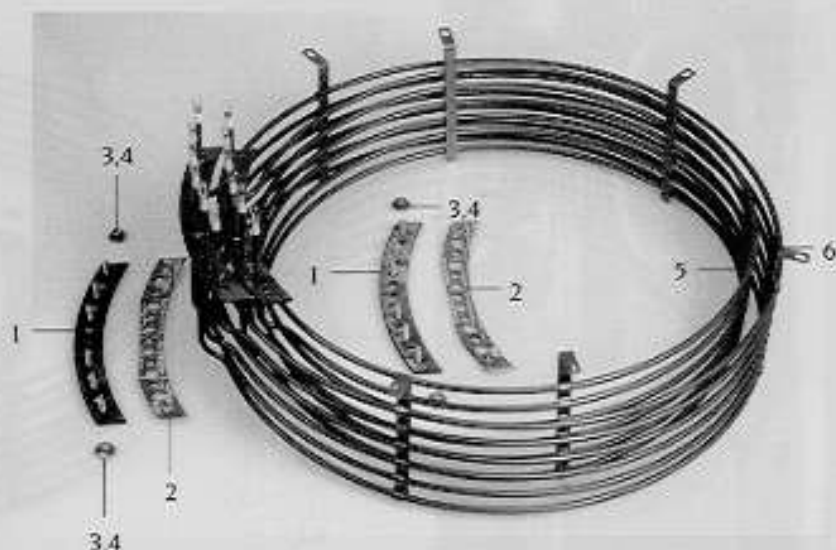

Pos.	St.	Ersatz.Nr.	Bezeichnung	Description
Pos.	Pcs.	Sp. Part No.		
1	4	2150.1005	Flansch Außenseite f. Heizregister	External flange for heating element
2	8	5110.1009	Dichtring f. Heizregister	Seal ring for heating assembly
3	36	1206.0261	Federring B6	Spring washer B6
4	36	1106.0360	Hutmutter M6	Cap nut M6
5	2	3200.1000	Heizregister Innen 230V	Inner heating assembly 230V
6	2	3200.1001	Heizregister außen 230V	Outer heating assembly 230V

Garraum Interior Cabinet	Spannung Voltage 3 N AC 400V 50Hz	Baugruppe Group 7	Ausgabe Edition 7.1.1	gültig ab Seriennummer Application from Serial.No. C21D93065001
-----------------------------	---	-------------------------	-----------------------------	---

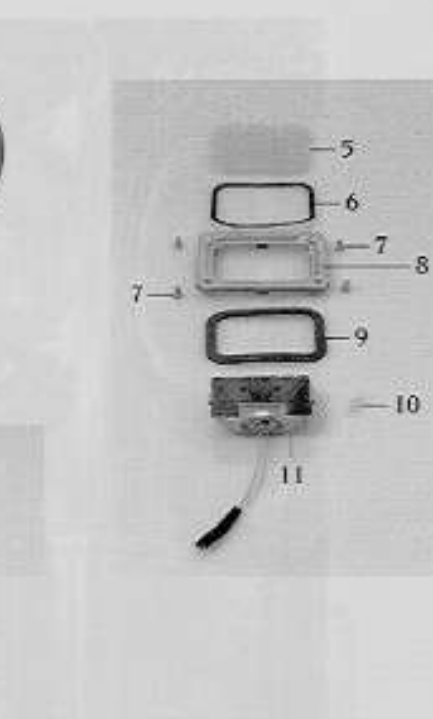
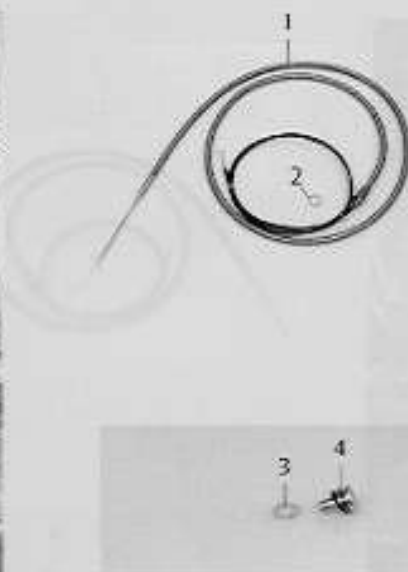
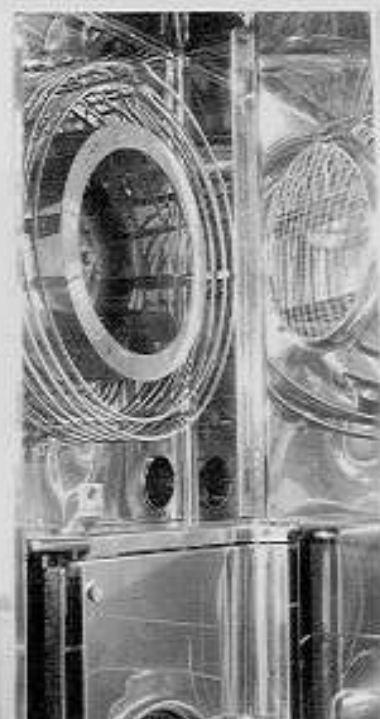

Pos.	St.	Ersatz.Nr.	Bezeichnung	Description
Pos.	Pcs.	Sp. Part No.		
-	1	8516.1035	Luftleitblech oben	Air baffle top
-	1	8516.1015	Luftleitblech unten	Air baffle bottom
-	1	2005.0302	Ablaufsieb	Outlet sieve
1	1	3035.0702	Einstechfühler	Meat probe sensor
2	1	1315.0105	Kupferdichtung für Einstechfühler	Copper gasket for meat probe sensor
3	4	2043.0203	Haltescheibe für Verschlussbolzen	Holder plate for air baffle
4	4	2043.0201	Verschlussbolzen für Luftleitblech	Locking pin for air baffle
5	2	5201.1000	Glas f. Garraumbeleuchtung	Glass for interior lamp
6	2	5110.1022	Dichtungsrahmen außen f. Garraumbeleuchtung	External gasket frame
7	8	1008.0753	Sechskantschraube M5x8	Hexagonal screw M5x8
8	2	8514.1017	Andrückrahmen f. Garraumbeleuchtung	Press down frame
9	2	5110.1023	Dichtungsrahmen innen	Internal gasket frame
10	2	3024.0201	Halogengarraumlampe 10 W/12V/300°C	Halogen bulb 10 W/12V/300°C
11	2	8514.1018	Reflektor kpl. f. Garraumbeleuchtung	Reflector unit for interior lighting



<b>Motor und Lüfterrad</b> <b>Motor and Fan Wheel</b>	<b>Spannung</b> <b>Voltage</b>	<b>Baugruppe</b> <b>Group</b>	<b>Ausgabe</b> <b>Edition</b>	<b>gültig ab Seriennummer</b> <b>Application from Serial.No.</b>
	3 N AC 400V 50Hz	6	6.1.1	C21D93065001

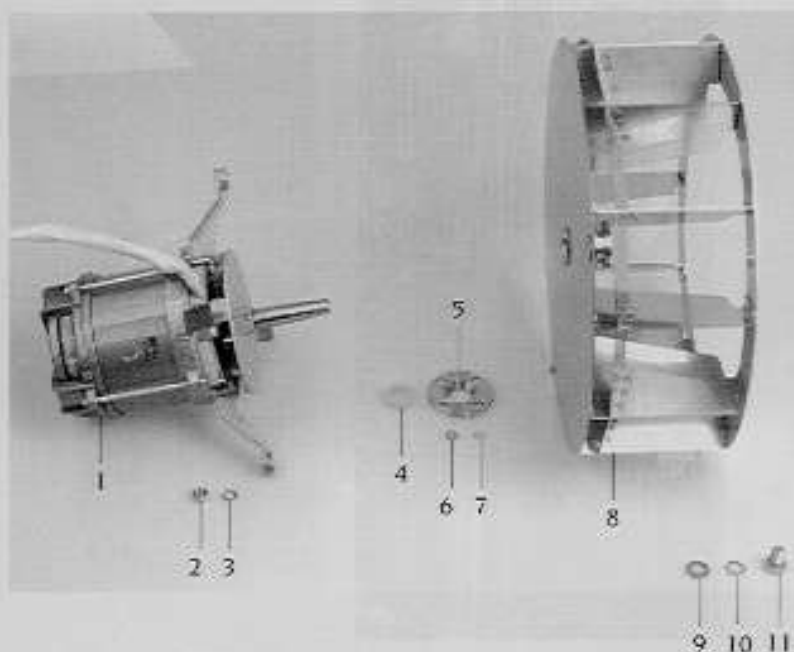
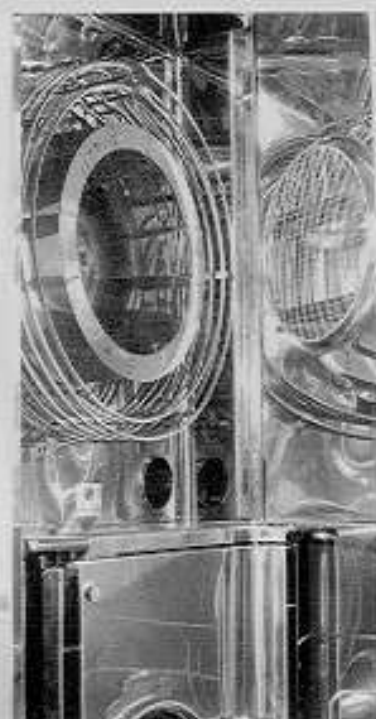

Pos.	St.	Ersatz.Nr.	Bezeichnung	Description
Pos.	Pcs.	Sp. Part No.		
1	2	3100.1002	Lüftermotor	Fan motor
2	8	1108.0260	Sechskantmutter M 8	Hexagonal nut M8
3	8	1208.0160	Zahnscheibe d 8,4	Toothed disc d 8.4
4	2	5001.0207	Motorwellendichtung	Motor shaft gasket
5	2	2016.0876	Dichtungsflansch für Motorwelle	Gasket flange for motor shaft
6	8	1106.0220	Sechskantmutter M6 flach	Hexagonal nut M6 flat
7	8	1315.0101	Kupferdichtung 6x10	Copper gasket 6x10
8	2	2012.0900	Lüfterrad	Fan wheel
9	2	1310.0160	Zahnscheibe A 10,5	Toothed disc A 10.5
10	2	1210.0160	Unterlegscheibe A 10,5	Washer A 10.5
11	2	1010.0760	Sechskantschraube M 10x16	Hexagonal screw M10x16

Dampfgenerator Steam Generator	Spannung Voltage	Baugruppe Group	Ausgabe Edition	gültig ab Seriennummer Application from Serial.No.
	3 N AC 400V 50Hz	4	4.1.1	C21D93065001

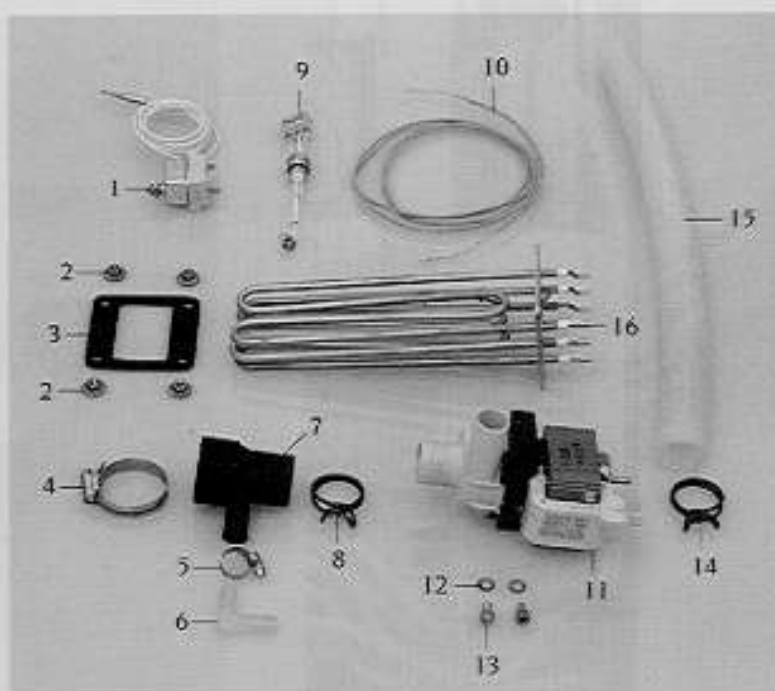
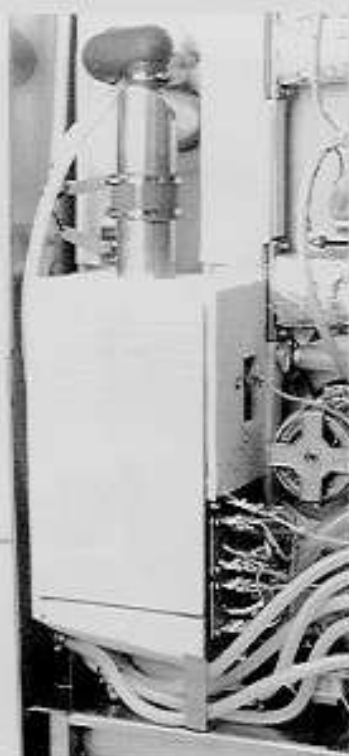

Pos.	St.	Ersatz.Nr.	Bezeichnung	Description
Pos.	Pcs.	Sp. Part No.		
-	1	8350.5000	Dampfgenerator kpl.	Steam generator unit
1	1	3014.0300	Trockengeschutz 125 °	Dry up protector 125 °
-	2	2740.1040	Klemmblech Dampfgenerator	Clamping plate for steam generator
2	16	1106.0801	Sechskant-Combi-Mutter M 6	Hexagonal combination nut M6
3	4	5110.1003	Dichtung f. Tauchheizkörper	Gasket for heating element
4	1	2066.0507	Schlauchschelle 32-50mm	Hose clamp 32-50mm
5	2	2066.0205	Schlauchschelle 12-18mm	Hose clamp 12-18mm
6	1	2062.0301	Winkelstück Kunststoff WS 10	Elbow piece plastic WS 10
7	1	2118.1000	Pumpenanschlußstutzen	Pump connection spout
8	1	2066.0519	Schlauchklemme 35,6mm	Hose clamp 35.6mm
9	1	3002.0402	Füllstandselektrode 90mm.	Filling level electrode 90 mm
10	1	3014.0165	Thermoelement Dampfgenerator	Thermo element steam generator
11	1	3002.1000	Entleerungspumpe 200-240V 50/60Hz	Emptying pump 200-240V 50/60Hz
12	2	1306.0120	Unterlegscheibe A6.4	Washer A6.4
13	2	1006.0621	Innensechskantschraube M 6x12	Allen screw M6x12
14	1	2066.0522	Schlauchklemme 31,3mm	Hose clamp 31.3mm
15	1	2112.1008	Entleerschlauch 22x4x575	Emptying hose 22x4x575
16	4	3201.1000	Tauchheizkörper 3x3 kw/230V	Heating element 3x3 kw/230V

<b>Elektromontageplatte</b> Electrical Installation	Spannung Voltage	Baugruppe Group	Ausgabe Edition	gültig ab Seriennummer Application from Serial.No.
	3 N AC 400V 50Hz	2	2.1.1	C21D93065001

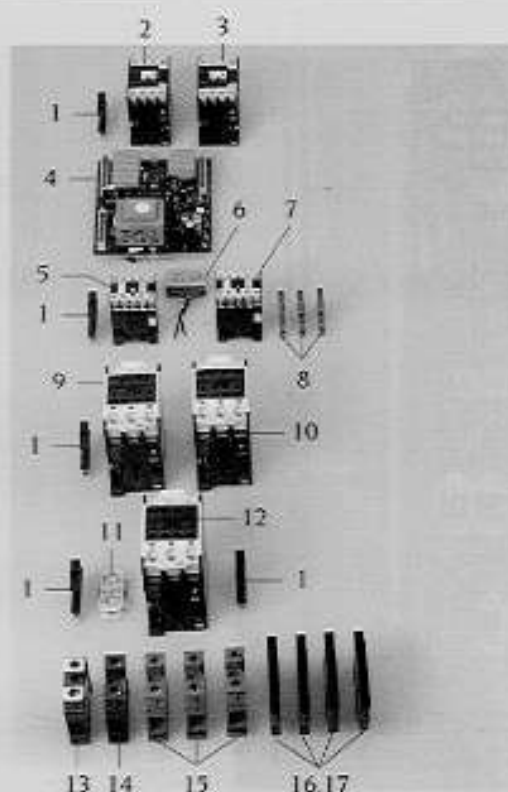
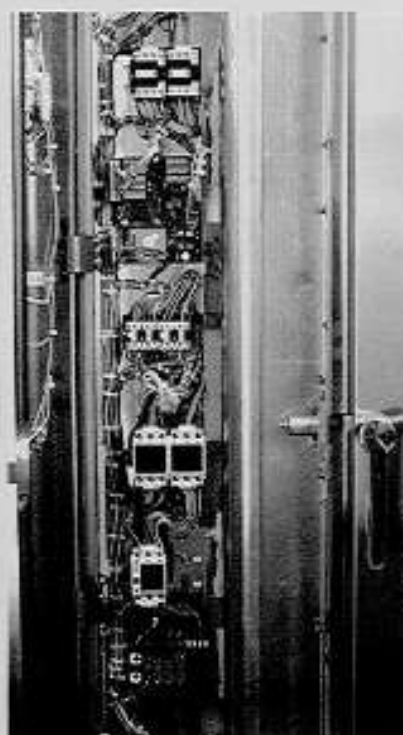

Pos.	St.	Ersatz.Nr.	Bezeichnung	Description
Pos.	Pcs.	Sp. Part No.		
1	5	4001.1203	Endklammer für Tragschiene	End plate for supporting rail
2	1	3028.0509	Schütz LS 17.01 220-240V 50/60Hz	Contacteur LS 17.01 220-240V 50/60Hz
3	1	3028.0509	Schütz LS 17.01 220-240V 50/60Hz	Contacteur LS 17.01 220-240V 50/60Hz
4	1	3040.2060	Regelplatine Wasserstand	PCB water level
-	2	3040.0245	Steckerleiste BL 11	Multipoint connector BL 11
-	1	3040.0244	Steckerleiste BL 10	Multipoint connector BL 10
5	1	3028.0504	Schütz LS 05.01 230V 50/60Hz	Contacteur LS 05.01 230V 50/60Hz
6	1	3102.1000	Wechselspannungskondensator 1,5 uF,250V	Capacitor 1,5 uF,250V AC
7	1	3028.0504	Schütz LS 05.01 230V 50/60Hz	Contacteur LS 05.01 230V 50/60Hz
8	3	4001.1216	Reihenklemme 4mm <sup>2</sup> grau	Terminal 4mm <sup>2</sup> grey
9	1	3028.0512	Schütz LS 37.00 220-240V 50/60Hz	Contacteur LS 37.00 220-240V 50/60Hz
10	1	3028.0512	Schütz LS 37.00 220-240V 50/60Hz	Contacteur LS 37.00 220-240V 50/60Hz
11	1	3028.0156	Hilfskontaktschalter HS 107	Auxiliary contact switch HS 107
12	1	3028.0512	Schütz LS 37.00 220-240V 50/60Hz	Contacteur LS 37.00 220-240V 50/60Hz
13	1	4001.1233	Erdungsreihenklemme 35mm <sup>2</sup> gelb/grün	Earth terminal 35mm <sup>2</sup> yellow/green
14	1	4001.1252	Reihenklemme 35mm <sup>2</sup> blau	Terminal 35mm <sup>2</sup> blue
15	3	4001.1206	Reihenklemme 35mm <sup>2</sup> grau	Terminal 35mm <sup>2</sup> grey
16	4	4001.1247	Sicherungsklemme	Safety terminal
17	4	4001.0218	Feinsicherung 6,3A	Fuse 6.3A